

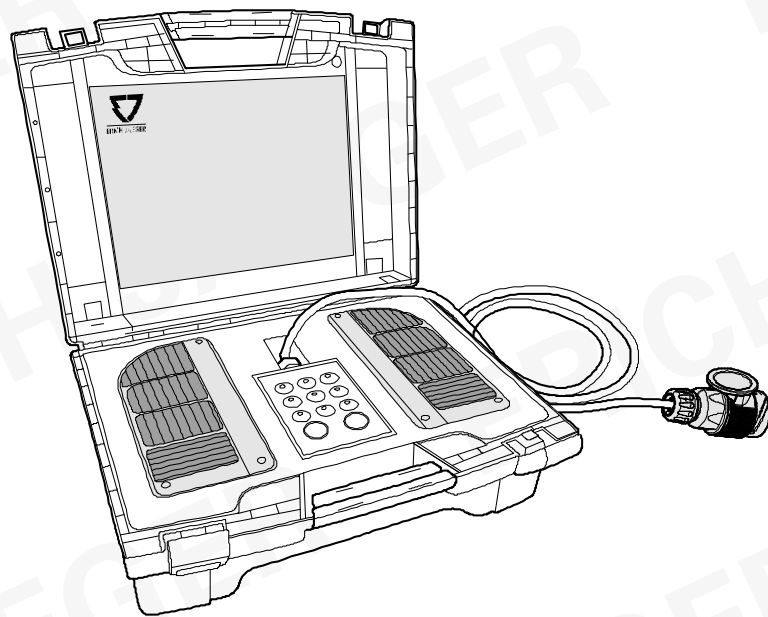

ERICH JAEGER



Anhängerprüfgerät Trailer Testing Unit 7P/12V + 13P/12V

361062

Für das Funktionsvideo scannen
Scan for application video



- | | |
|---------------------------------|--|
| (D) Einbauanleitung | (PL) Instrukcja montażu |
| (GB) Installation instructions | (TR) Montaj talimatı |
| (F) Consignes de montage | (H) Beépítési útmutató |
| (NL) Montagehandleiding | (HR) Upute o ugradnji |
| (DK) Montagevejledning | (BUL) Инструкция за монтаж |
| (N) Monteringsinstruksjon | (RO) Instrucțiuni de montaj |
| (S) Installationsanvisning | (RU) Инструкция по монтажу и установке |
| (FIN) Asennusohje | (LT) Montavimo informacija |
| (I) Istruzioni per il montaggio | (LV) Iemontēšanas pamācība |
| (E) Instrucciones de montaje | (EST) Paigaldusjuhend |
| (P) Instruções de montagem | (SLO) Navodilo za vgradnjo |
| (GR) Οδηγίες εγκατάστασης | (SK) Montážny návod |
| (CZ) Návod k montáži | |



OPTION 1

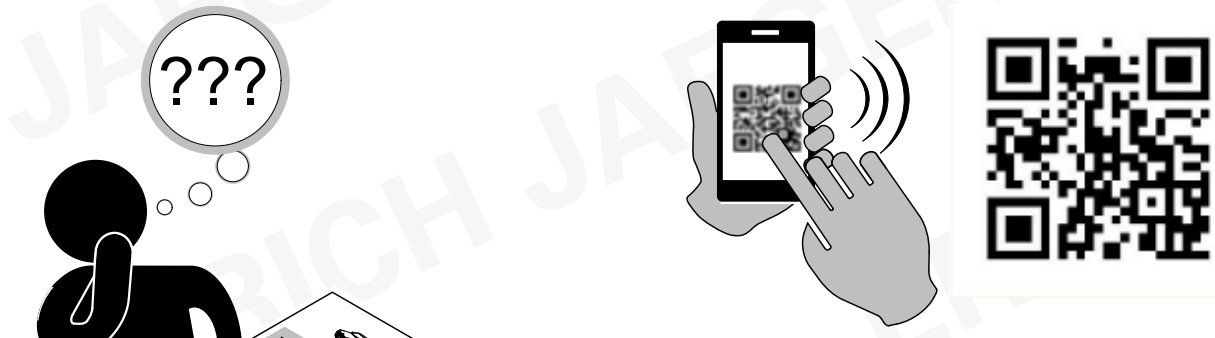

OPTION 2









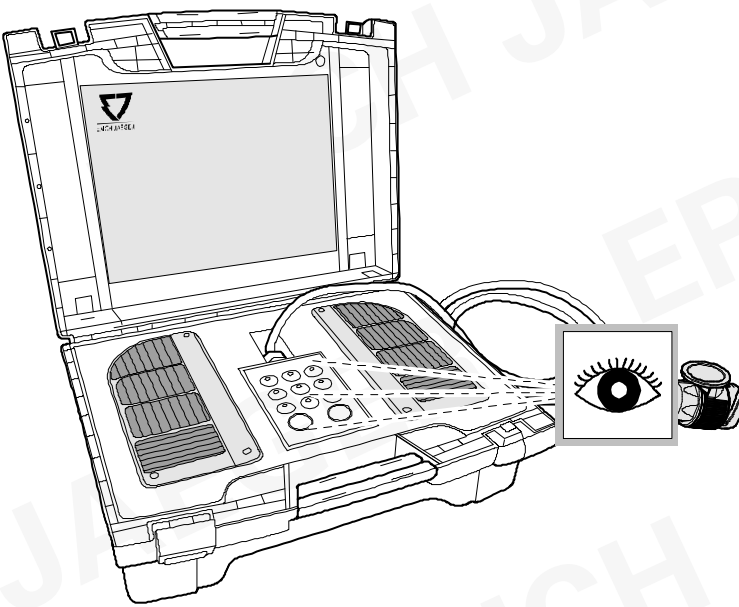

www.erich-jaeger.com

- Service & Support
- FAQ

WWW 

1 INFORMATION



	LEFT LIGHT
	REVERSE LIGHT
	RIGHT LIGHT
	LEFT TURN INDICATOR
	RIGHT TURN INDICATOR
	REAR FOG LIGHT
	STOP LIGHT
	POWER SUPPLY
	POWER SUPPLY
	RIGHT FAULT DETECTION SWITCHER
	LEFT FAULT DETECTION SWITCHER

2

13pin

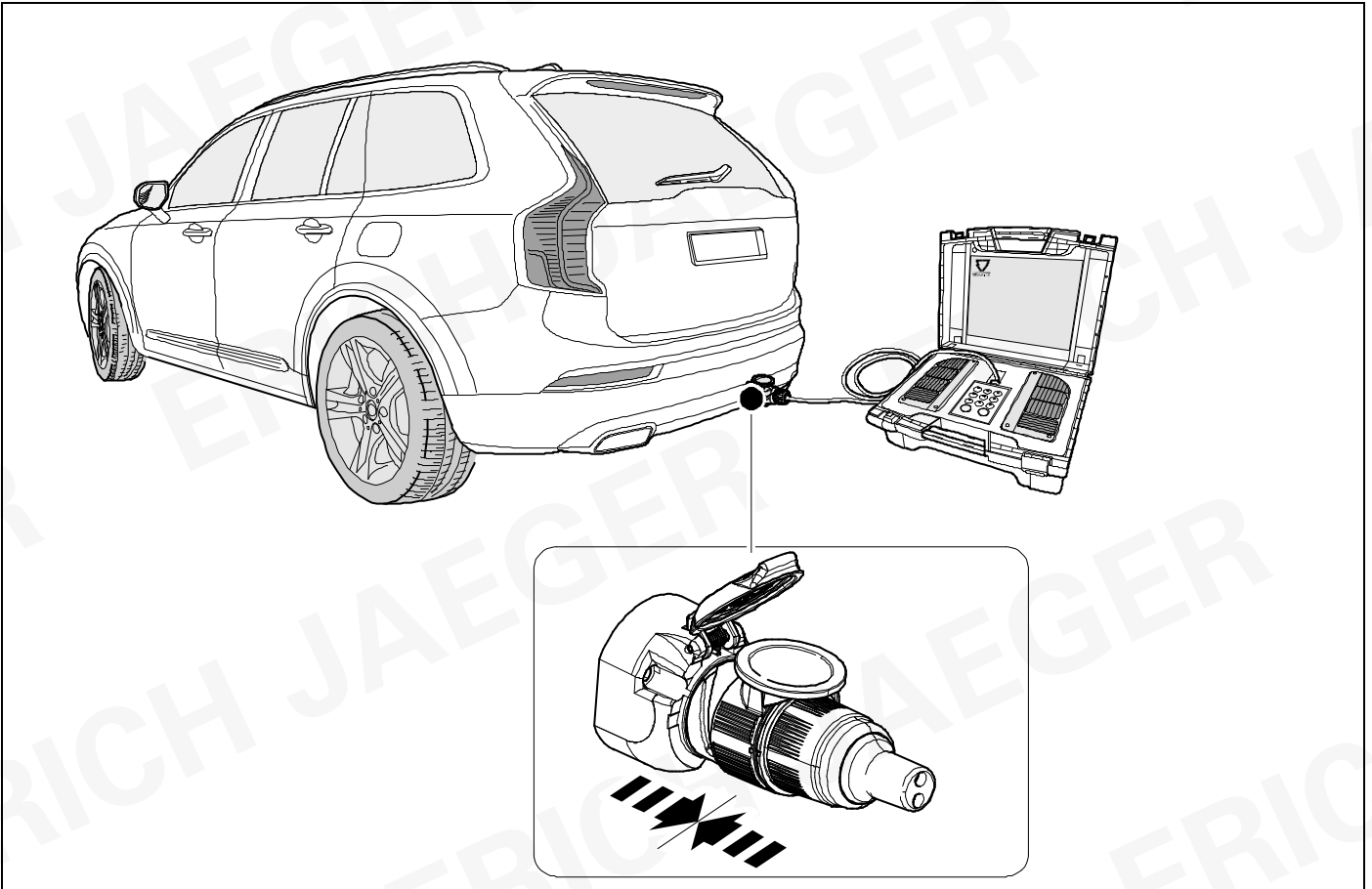

3

7pin

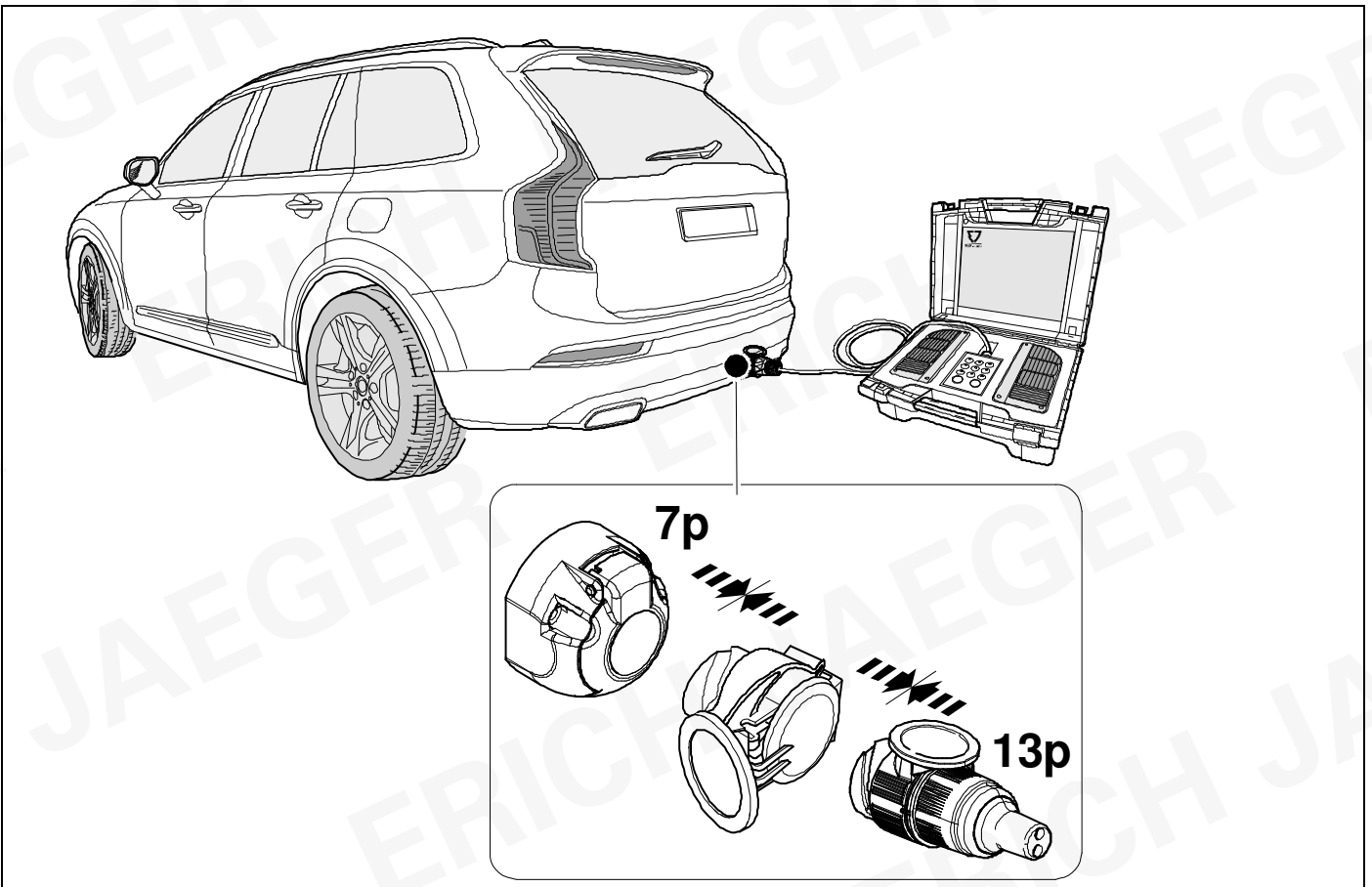

4 CHECK

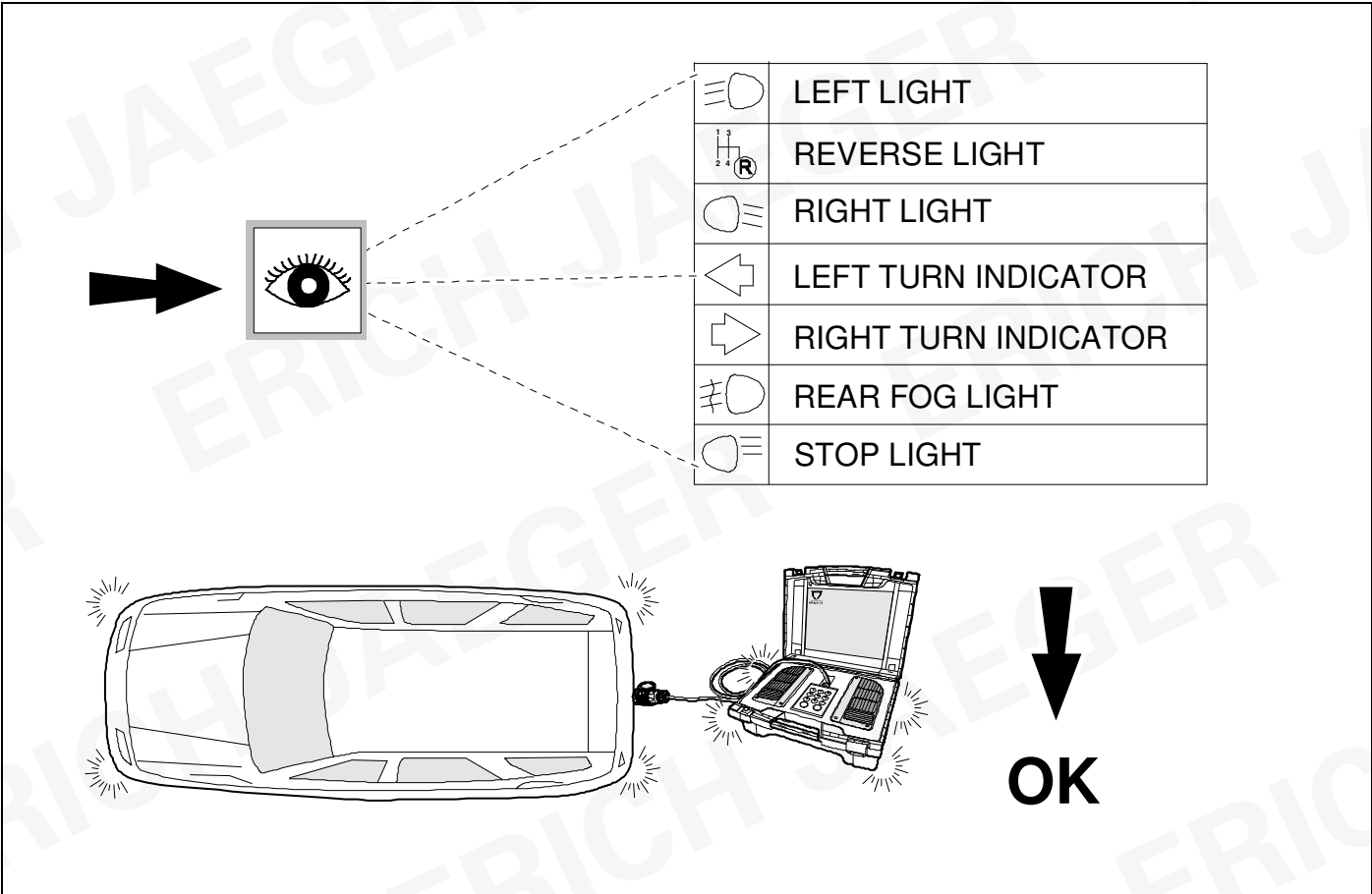

5 CHECK

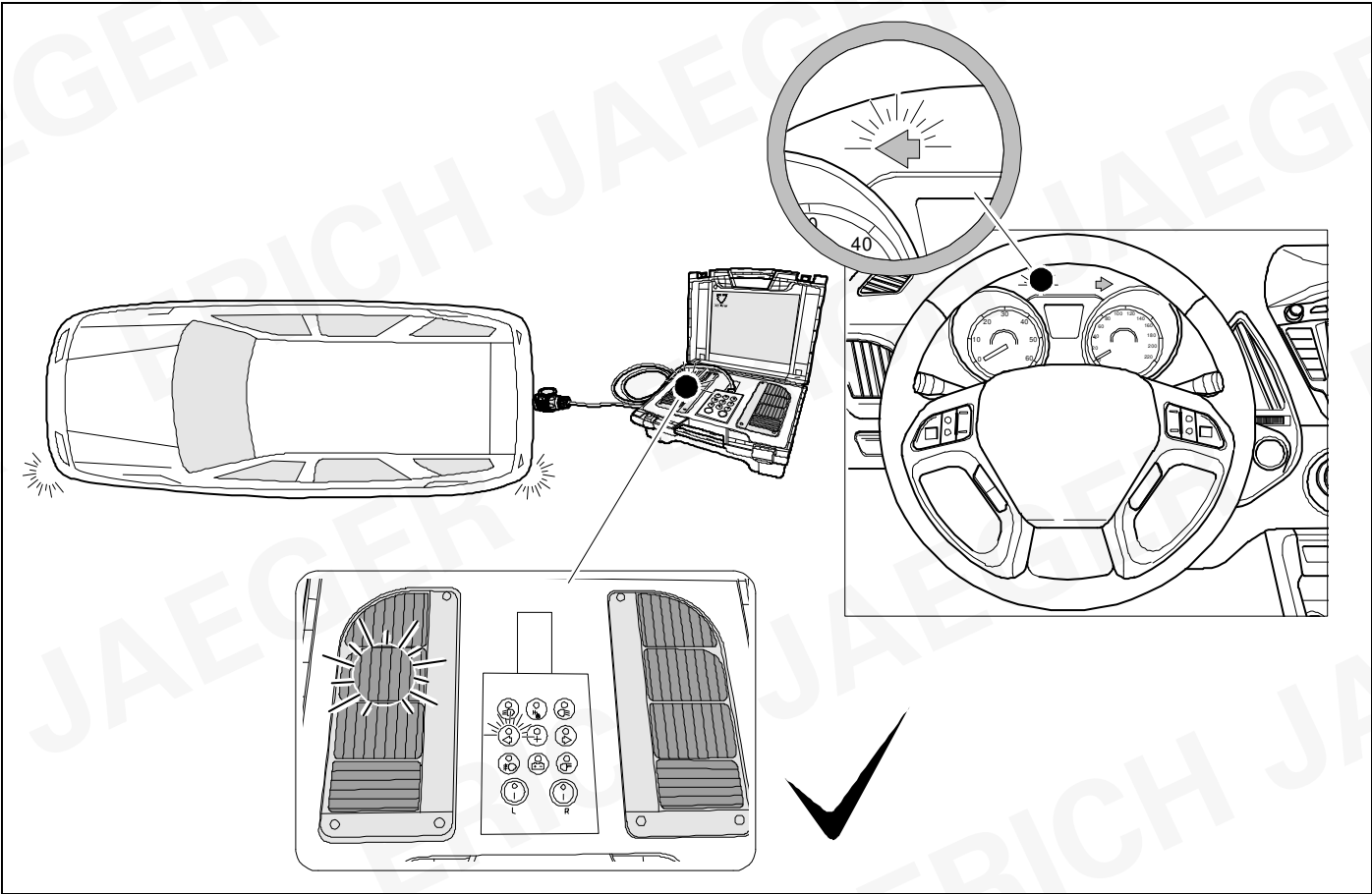

6 CHECK

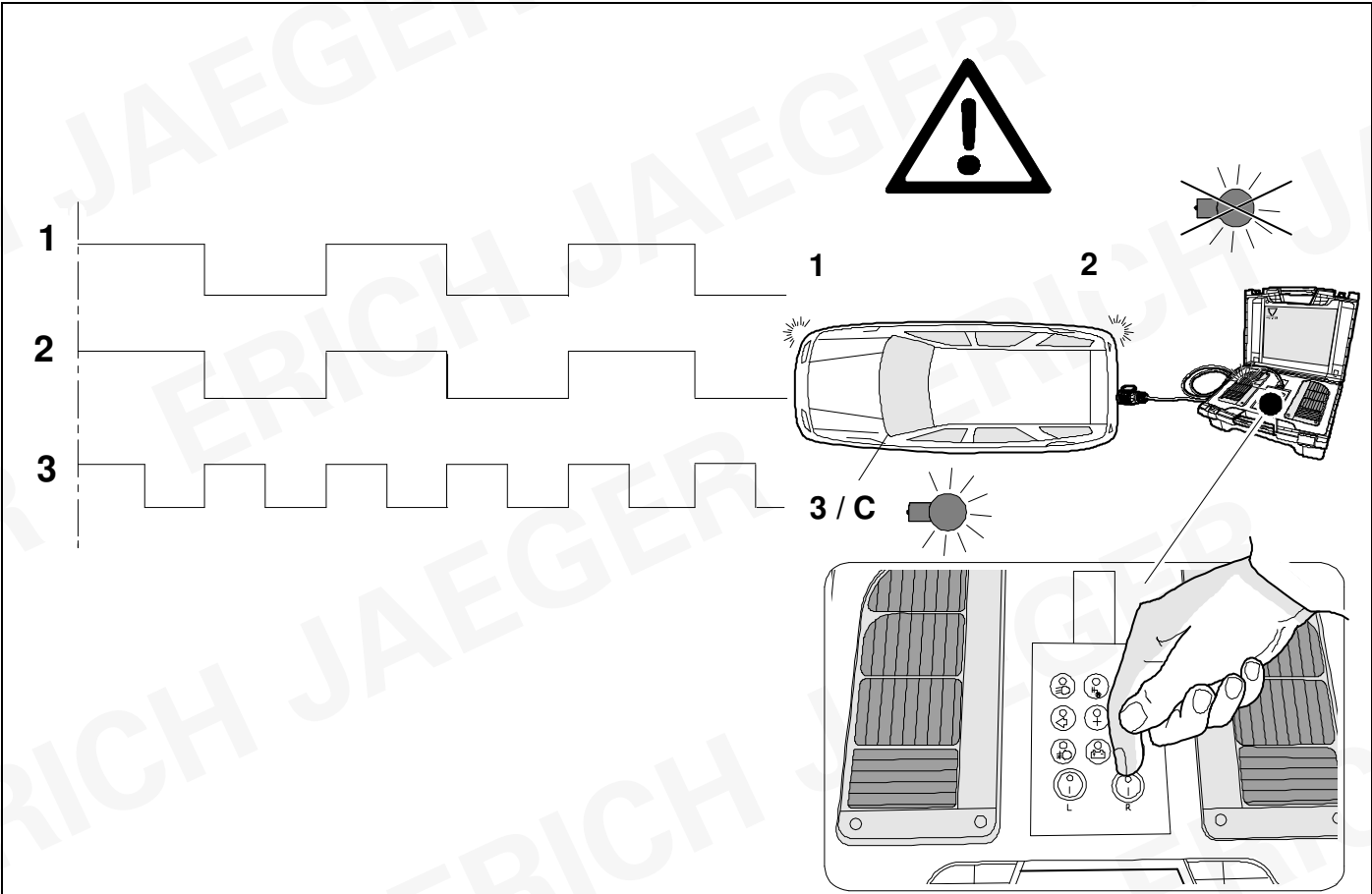

7 INFORMATION

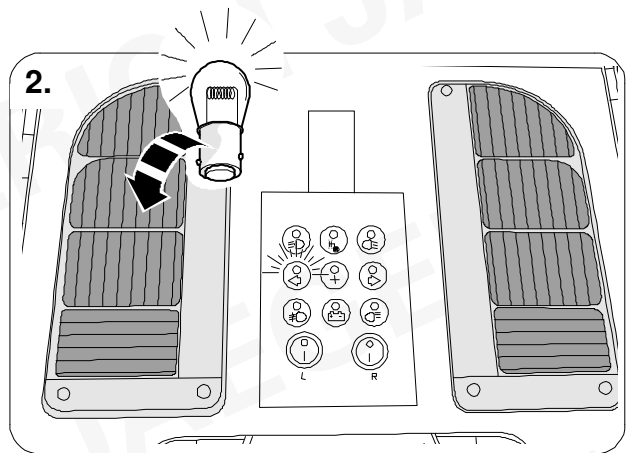
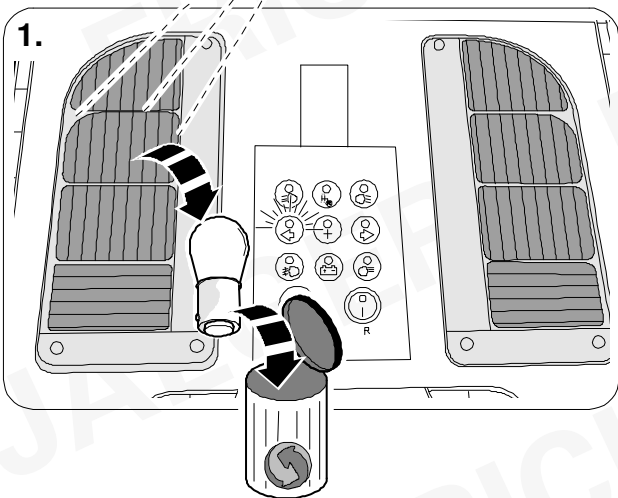
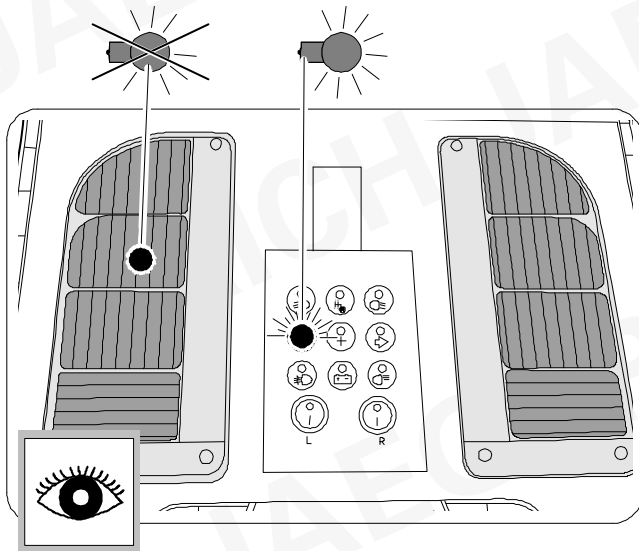
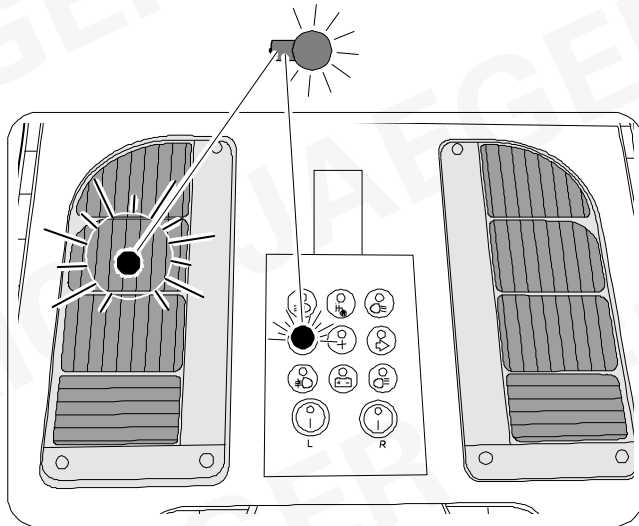

ERICH JAEGER

D	Änderungen bezüglich Konstruktion, Ausstattung Farbe sowie Irrtum vorbehalten. Angaben und Abbildungen unverbindlich	PL	Zastrzega się prawo do zmian dot. konstrukcji, wykończenia, kolorystyki oraz pomylek. Dane i ilustracje niewiążące.
GB	Subject to change in terms of construction, equipment and colour, and may contain errors. The information and illustrations are non-binding.	TR	Tasarım, donanım ve renk bakımından değişiklik yapma hakkı ve hata ve eksiklik mahfuzdur. Veriler ve resimler bağlayıcı değildir.
F	Sous réserve de modifications de la construction, de équipement, de la couleur et sous réserve d'erreurs. Les indications et les illustrations sont sans engagement.	H	A szerkezet, a kivitel és a szín változtatása, valamint a változások joga fenntartva. Az adatok és az ábrák nem kötelező érvényűek.
NL	Wijzigingen met betrekking tot constructie, uitvoering en kleur evenals vergissingen voorbehouden. Gegevens en afbeeldingen niet bindend.	HR	Pravo promjena u svezi konstrukcije, opreme, boje kao i zabune oridžavamo. Podaci i ilustracije su neobavezne.
DK	Ændringer med hensyn til konstruktion, udstyr, farver samt fejl forbeholdes. Oplysninger og illustrationer er uforpligtende.	BUL	Запазени права по отношение на конструкцията, обзавеждането, цвета и грешки. Данните и изображенията не са обвързващи.
N	Ændringer angående konstruksjon, utstyr, farge og feiltagelse forbeholdes. Oplysninger og illustrasjoner uforbindtlig.	RO	Ne rezervăm dreptul unor modificări ale construcției, dotării, culorii și dreptul la erori Datele indicate și imaginile sunt orientative.
S	Med reservation för ändringar vad det gäller konstruktion, utrustning, färg samt för misstag. Uppgifterna och bilderna är inte bindande.	RU	Права на внесение изменений относительно конструкции, оснащения, окраски, а также на ошибки сохраняются. Данные и иллюстрации имеют примерный характер.
FIN	Pidätämme oikeuden rakennetta, varustusta, väriä koskeviin sekä erehdyksestä johtuviin muutoksiin. Tiedot ja kuvat eivät ole sitovia.	LT	Pasilieikama konstrukcijos, įrangos bei reikmenų, spalvos pakeitimų ir klaidų teisė. Duomenys ir iliustracijos neįpareigojantys.
I	Con riserva di modifche relative a progettazione, dotazione, colore ed errori. Le indicazioni e figure sono fornite senza impegno.	LV	Tiek paturētas tiesības uz konstrukcijas, iekārtu, krāsu izmaiņām, kā arī kļūdišanās. Dati un attēli bez saistībām.
E	Reservadas las modificaciones respecto a diseño, equipamiento, color, así como error. Indicaciones y figuras sin compromiso.	EST	Konstruktsooni, varustuse ja võervi osas muudatused ning eksimine lubatud. Andmed ja joonised on mittesiduvad.
P	Reservamos o direito de alterações relativamente ao desenho, equipamento, cor, bem como de erro. Os dados e as gravuras não implicam compromisso da nossa parte.	SLO	Zadržana pravica do sprememb glede konstrukcije, opreme, barve ter pomote. Podatki in slike so neobvezne.
GR	Διατηρώνουμε κάθε επιφύλαξη ως προς αλλαγές σε σχέση με κατασκευή, εξοπλισμό, διαρρύθμιση, χρωματισμούς και λάθη παραδρομής.	SK	Zmeny, ktoré sa týkajú konštrukcie, vybavenia, farby, ako aj omyly sú vyhradené. Údaje a zobrazenia sú nezáväzné.
CZ	Změny, týkající se konstrukce, vybavení, barvy, jakož i omyly jsou vyhrazeny. Údaje a vyobrazení jsou nezávazné.		