

IT Istruzioni di montaggio
 EN Fitting instructions
 DE Montageanleitung
 FR Instructions de montage
 ES Instrucciones de montaje
 BG инструкции за сглобяване
 CS Návod na montáž
 DA Monteringsvejledning
 EL Οδηγίες συναρμολόγησης

ET Paigaldusjuhend
 FI Asennusohje
 HR Uputa za sastavljanje
 HU A felszerelés módja
 LT Pritvirtinimo instrukcijos
 LV Stiprināšanas instrukcija
 NL Instrukcja montażu
 NO Monteringsveiledning
 PL Instrukcja montażu

PT Instruções de Montagem
 RO Instrucțiuni de montare
 RU Инструкции по установке
 SK Návod na montáž
 SL Navodila za pritrdjevanje
 SV Monteringsanvisning
 TK Uydurma talimat
 ZH 裝修指導
 AR كتيب التعليمات





Made in Italy



LE TRI
+ FACILE



N.	[IT]Componenti (Inclusi) [EN]Components (Included) [FR]Composants (Comprises) [DE]Die Komponenten (im Lieferumfang enthalten) [ES]Componentes (Incluido)	Q.
1	 M8x45	4
2		4

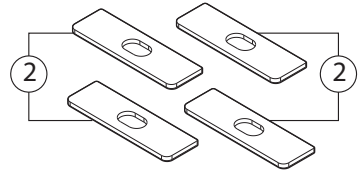
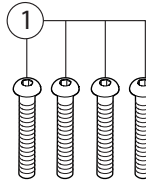

1

X4

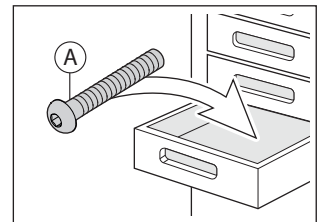
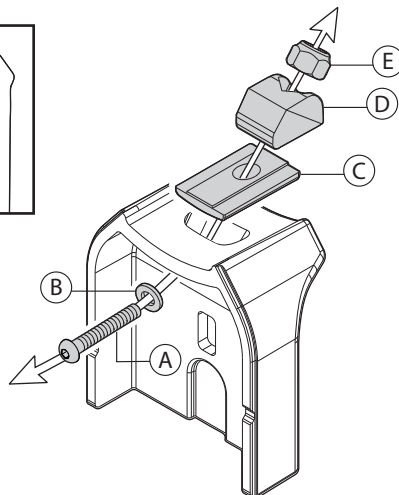
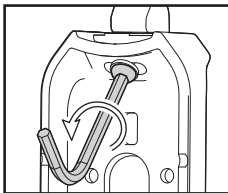

2

X4

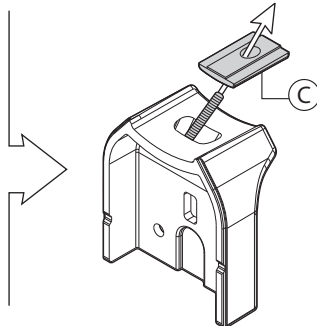
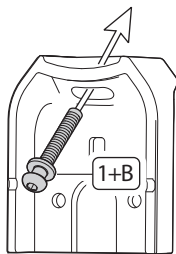
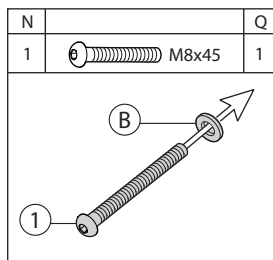

3

X4

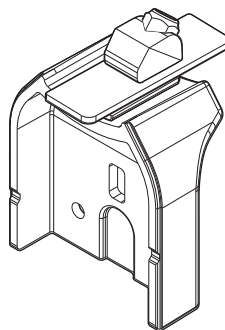
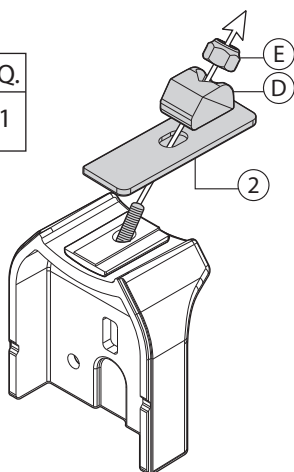
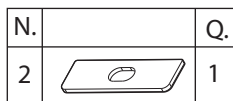

4

X2

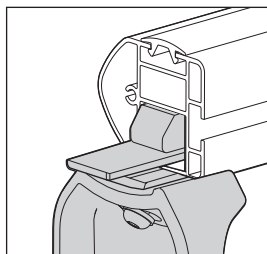
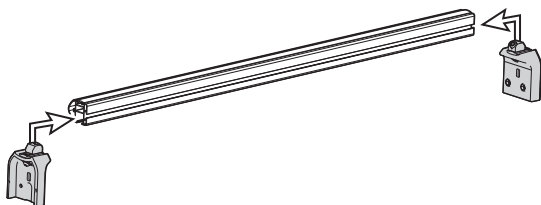

F.lli Menabò S.r.l.
 Via 8 Marzo, 3 -Z.I. Corte Tegge
 42025 Cavriago (RE) ITALY
 customercare@flli-menabo.it
 www.menabocaraccessories.com



500044000000
 03/07/2023